

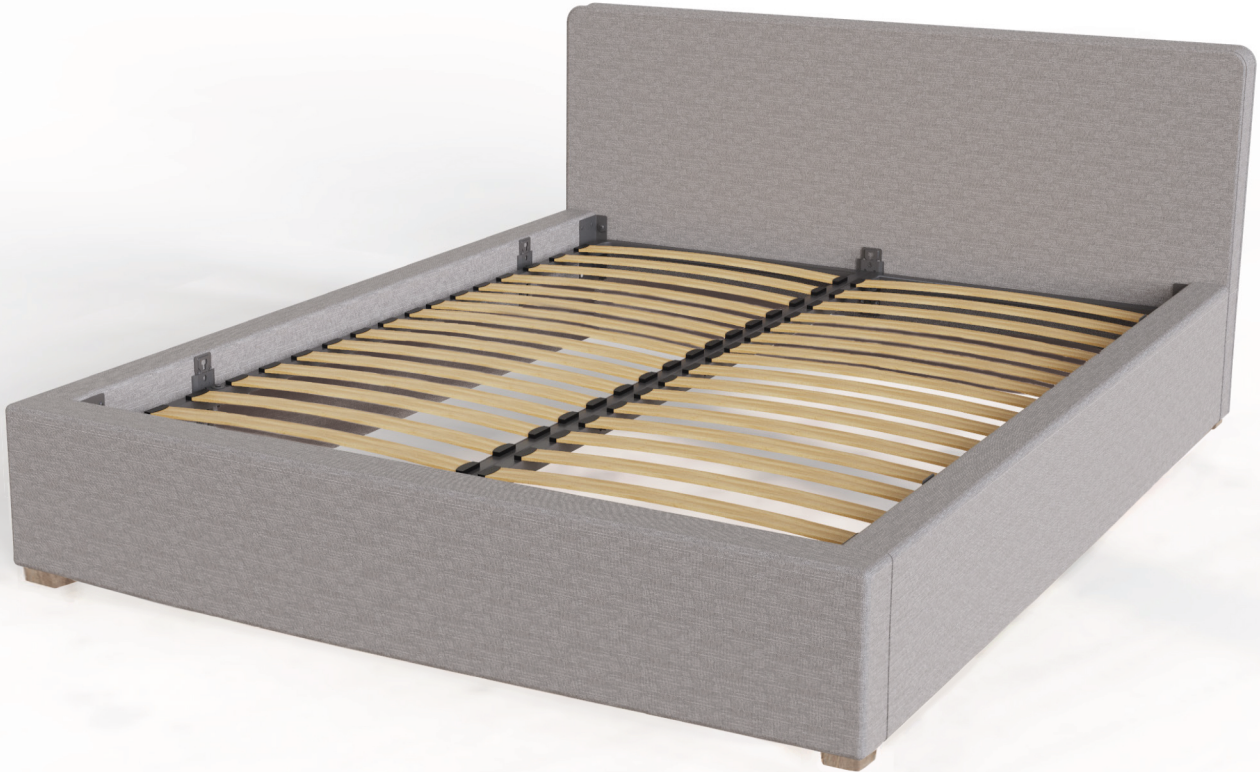





# Bed Frame Assembly Instruction Guide



## Supplied Fittings

A	B	C	D	E	F
					
x 1	x 9	x 4	x 4	x 5	x 6

01WM-01E 2019-05-19

Please check you have the correct fittings and read through before commencing with assembly

## Step 1

## Step 4

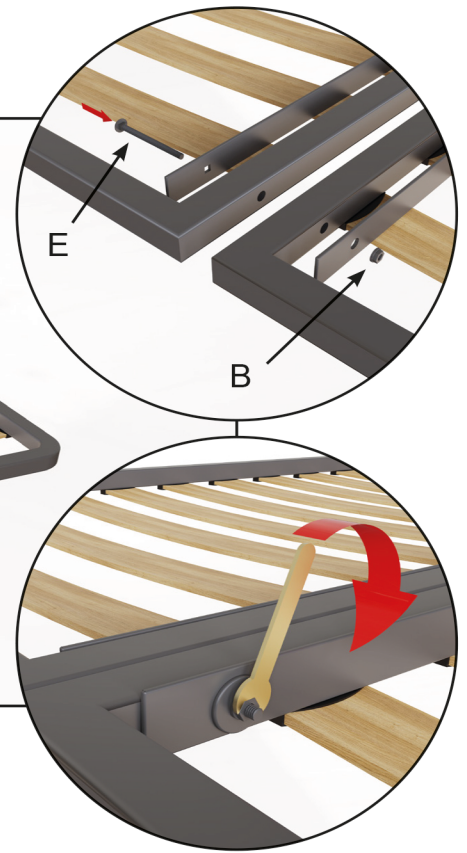
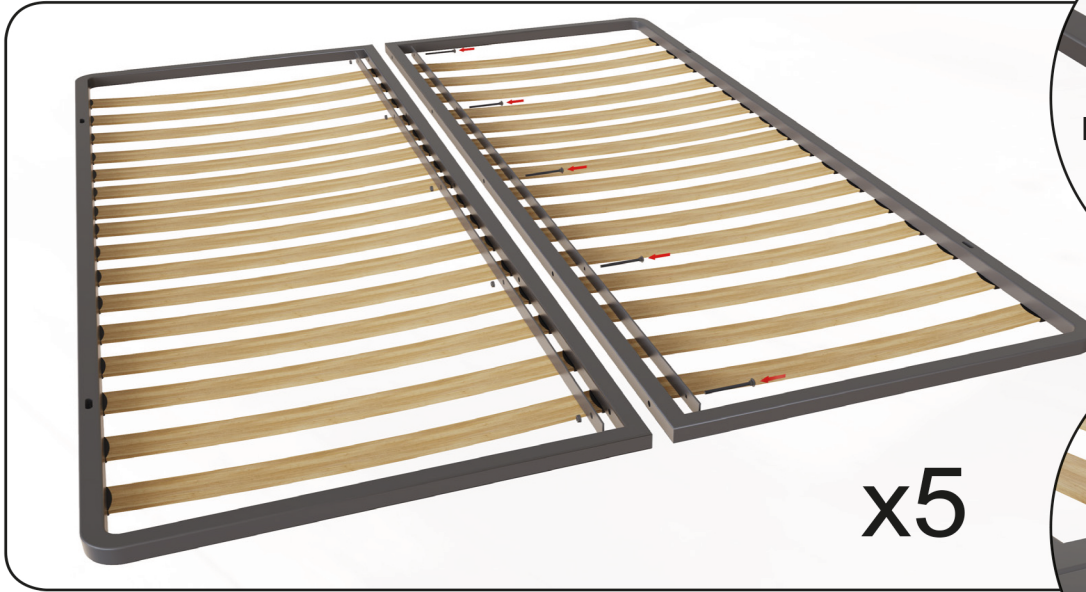

Place the 2 frames together and put the two flat bars on each side. Slot bolt (E) through, starting with the flat bar that has square holes. Use a flanged nut (B) and tighten up using the spanner provided.

Once completed, place the metal frame to one side. **Step 5**

## Step 2



Slot the side rail onto the bolts on the headboard.

**Quick tip:** It's easier to fit the side rails at a slight angle

## Step 3

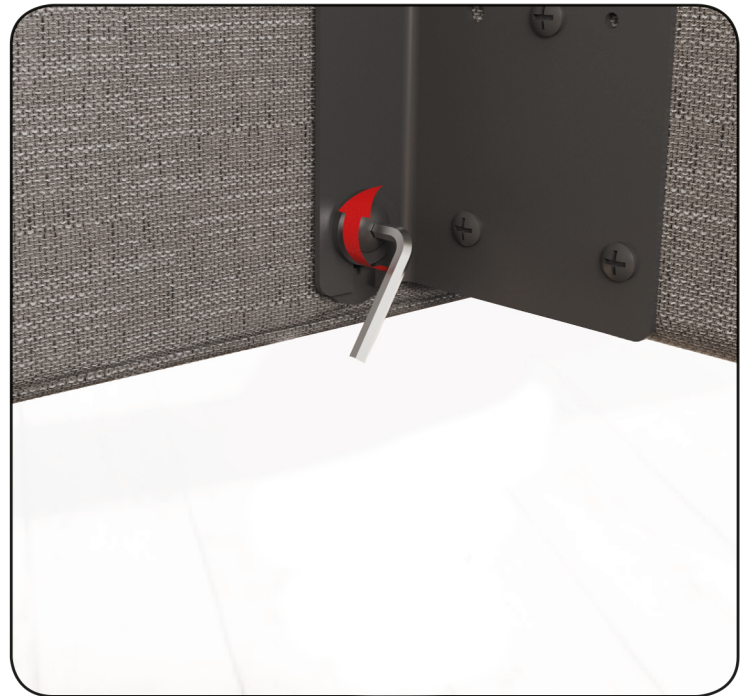

Use the allen key provided (A) to tighten the bolts onto the brackets

**Repeat steps 2 and 3 for both sides to attach the headboard and footend to the side rails**

## Step 4

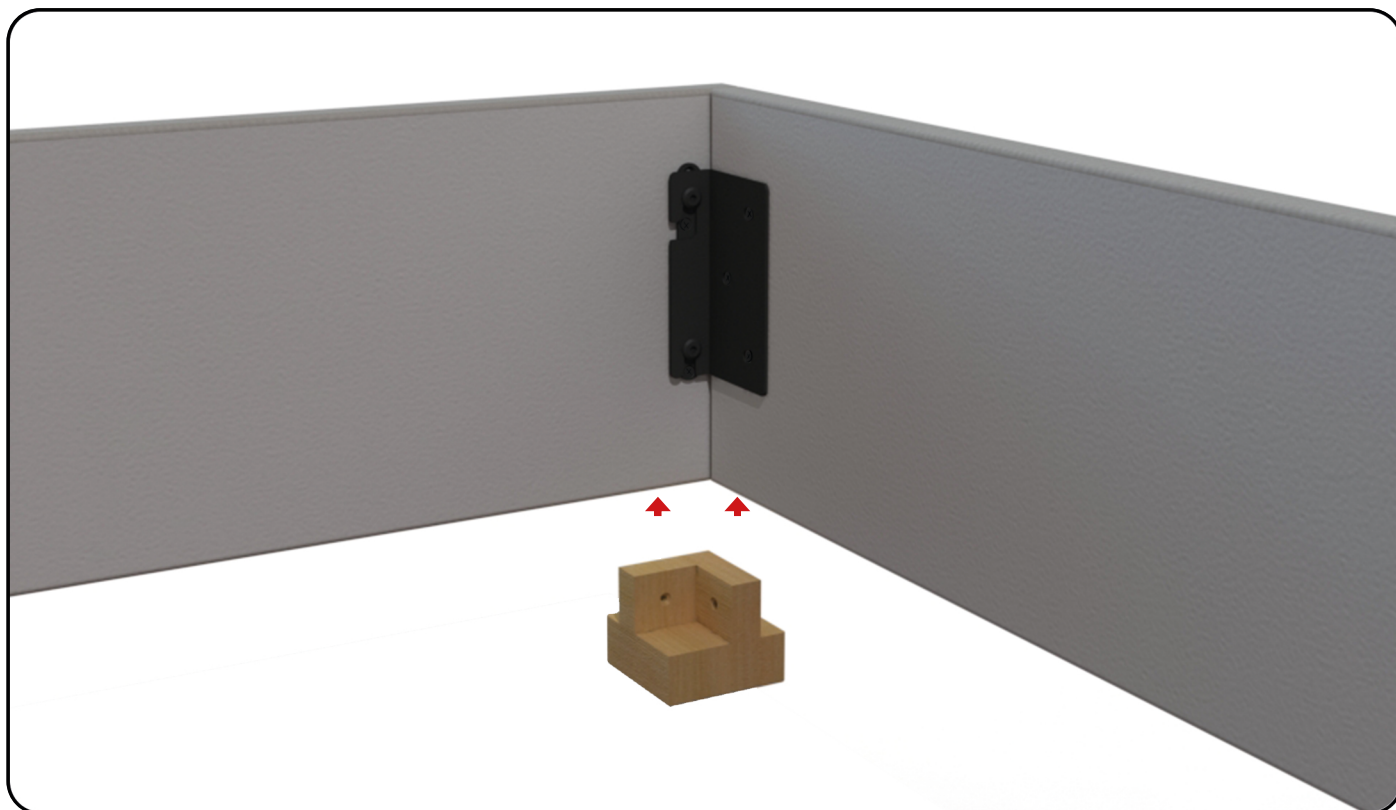

With help, starting at the headboard, lift the headboard slightly off the floor and slide the feet under each corner so that they sit tight in the corners.

## Step 5

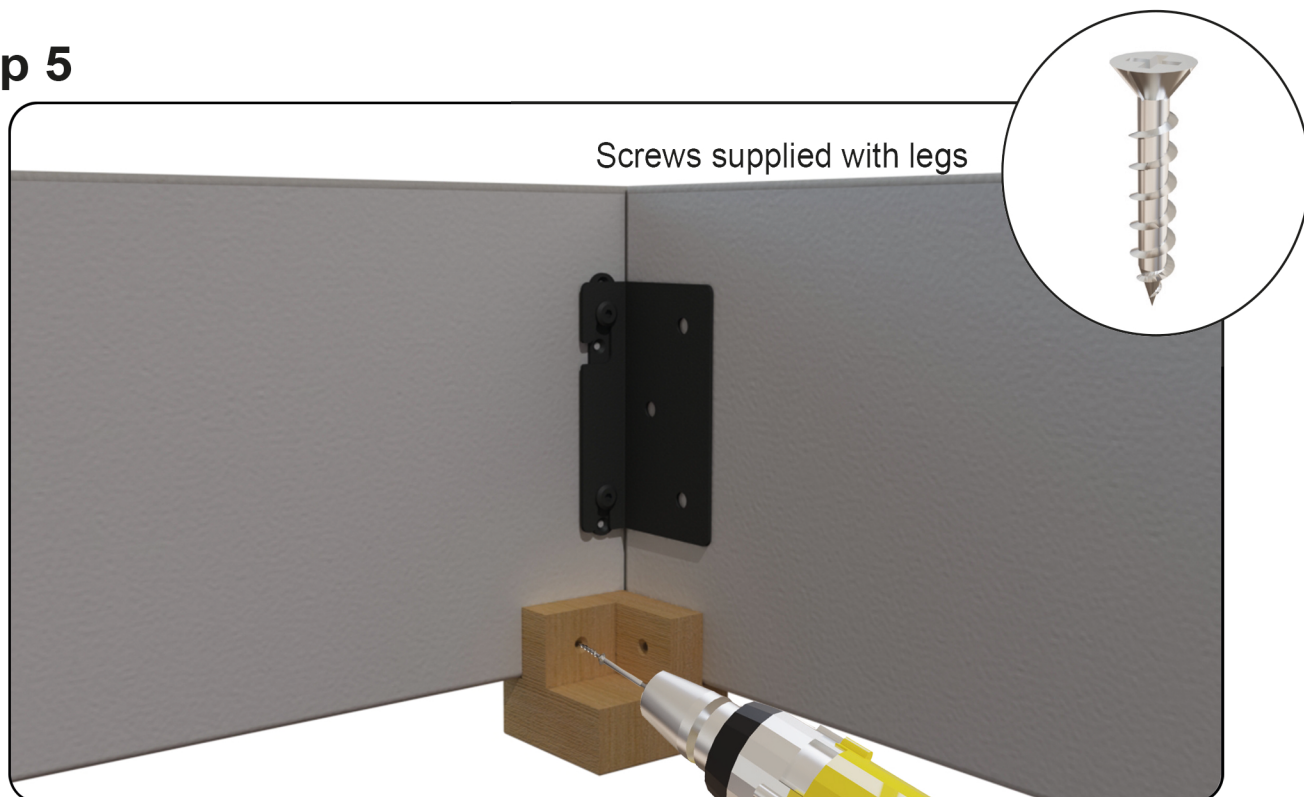

Fix the feet into position using screws provided. Use 2x screws per foot.

## Step 6

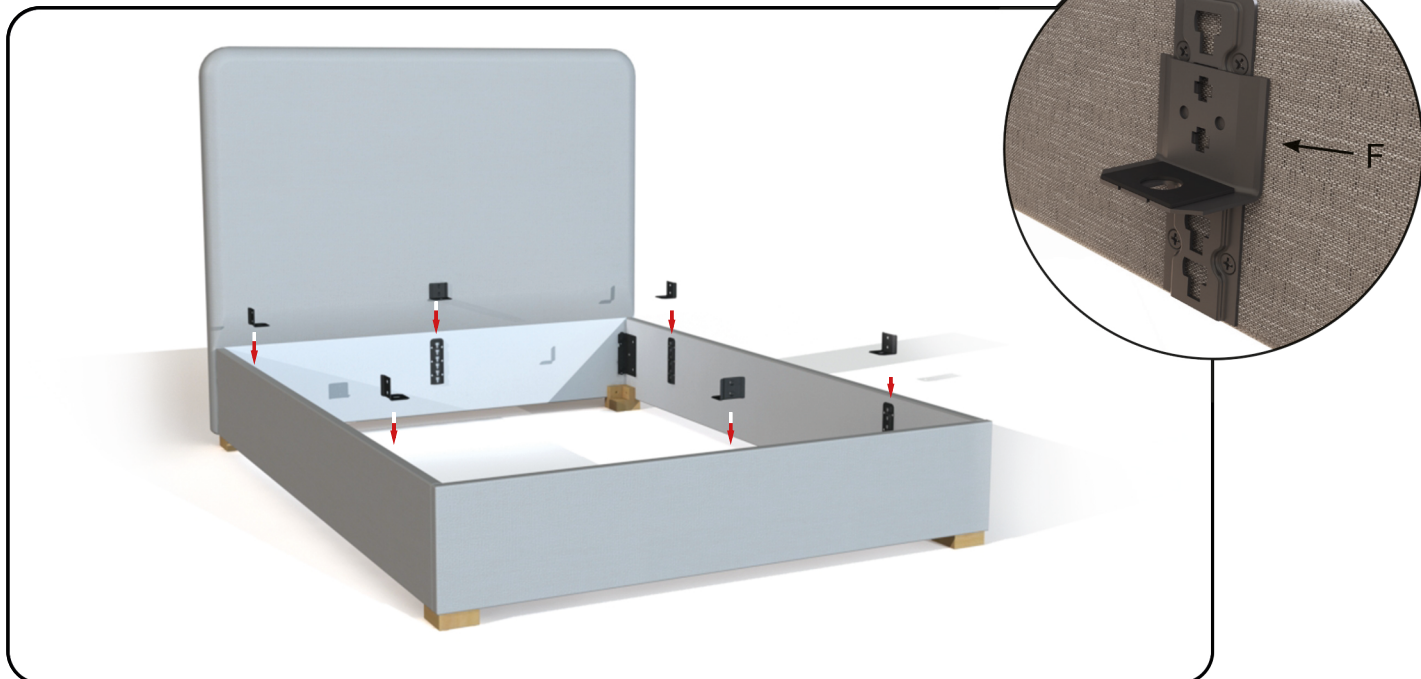

Slot the frame brackets (F) onto the side rails, footend and headboard in the desired position. Ensure all brackets are set at the same height level

## Step 7

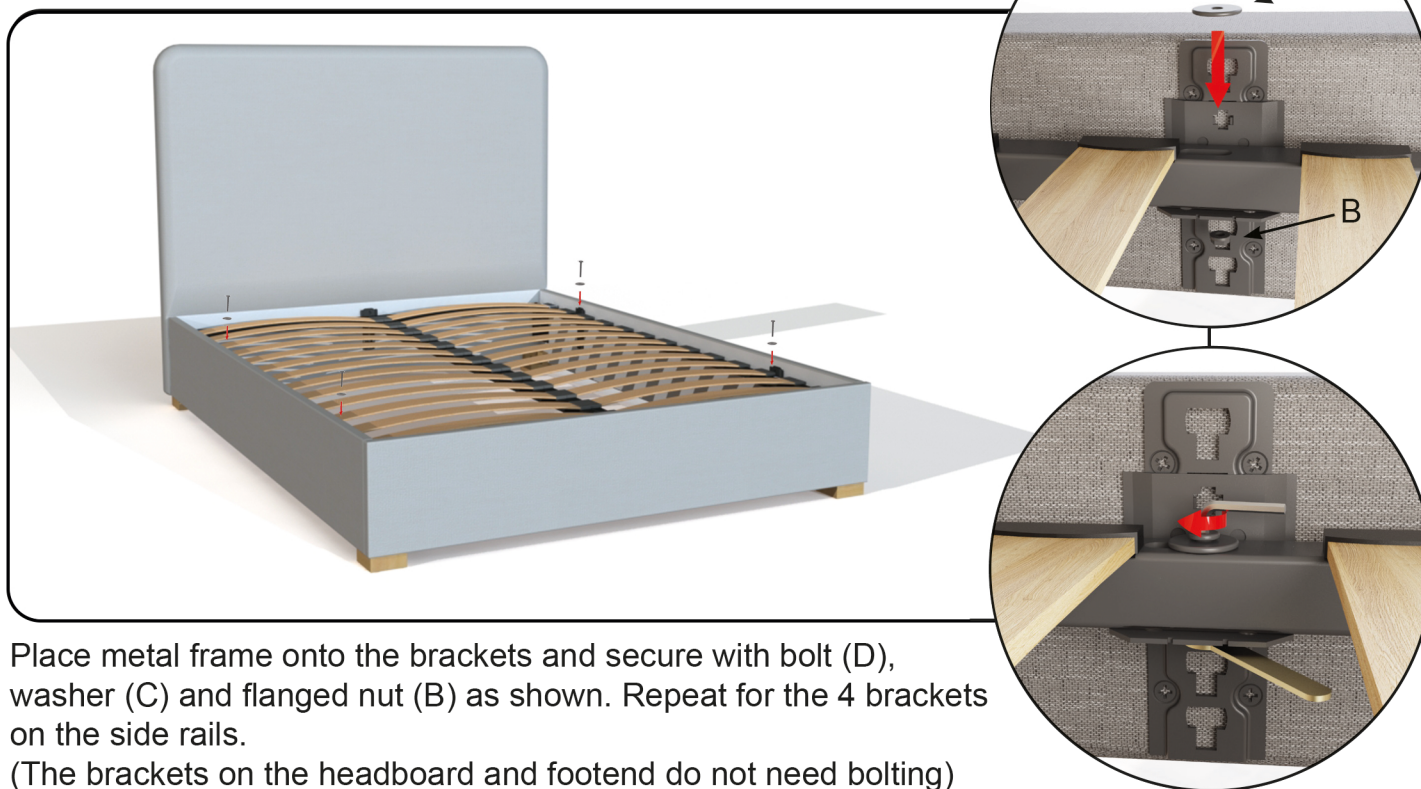

Place metal frame onto the brackets and secure with bolt (D), washer (C) and flanged nut (B) as shown. Repeat for the 4 brackets on the side rails.

(The brackets on the headboard and footend do not need bolting)

**Your bed is now fully assembled.**

**Please do not use without a mattress and periodically check that all fixings are tightened correctly**